

MITSUBISHI

ENGINE

4G6 SERIES

WORKSHOP MANUAL

FOREWORD

This Workshop Manual contains procedures for removal, disassembly, inspection, adjustment, reassembly and installation, etc. for service mechanics. All information, illustrations and product descriptions contained in this manual are current as at the time of publication. We, however, reserve the right to make changes at any time without prior notice or obligation.

Engine <1991 to 1992> **11A**

Engine **11B**
<1993 and subsequent>

FILING INSTRUCTION

Please keep these manual pages in the binder No. BN940001.

File these pages according to the signs "Added", "Revised" and "Deleted" on the "List of effective pages" which are interpreted below.

Added: File the pages with this label additionally in your manual.

Revised.Deleted: Replace the existing pages with the corresponding pages with this sign.

Missing sheets will be supplied upon request.

 **MITSUBISHI MOTORS CORPORATION**

INTRODUCTION

EXPLANATION OF MANUAL CONTENTS

Maintenance and Servicing Procedures

- (1) A diagram of the component parts is provided near the front of each section in order to give the reader a better understanding of the installed condition of component parts.
- (2) The numbers provided within the diagram indicate the sequence for maintenance and servicing procedures; the symbol  indicates a non-reusable part; the tightening torque is provided where applicable.

- **Removal steps:**
The part designation number corresponds to the number in the illustration to indicate removal steps.
- **Disassembly steps:**
The part designation number corresponds to the number in the illustration to indicate disassembly steps.
- **Installation steps:**
Specified in case installation is impossible in reverse order of removal steps. Omitted if installation is possible in reverse order of removal steps.
- **Reassembly steps:**
Specified in case reassembly is impossible in reverse order of disassembly steps. Omitted if reassembly is possible in reverse order of disassembly steps.





Classification of Major Maintenance/Service Points

When there are major points relative to maintenance and servicing procedures (such as essential maintenance and service points, maintenance and service standard values, information regarding the use of special tools, etc.), these are arranged together as major maintenance and service points and explained in detail.

- ◊A◊: Indicates that there are essential points for removal or disassembly.
▶A▶: Indicates that there are essential points for installation or reassembly.

Symbols for Lubrication, Sealants and Adhesives

Information concerning the locations for lubrication and for application of sealants and adhesives is provided, by using symbols, in the diagram of component parts, or on the page following the component parts page, and explained.

-  Grease
(multipurpose grease unless there is a brand or type specified)
-  Sealant or adhesive
-  Brake fluid, automatic transmission fluid
or air conditioner compressor oil
-  Engine oil or gear oil.

INTRODUCTION

Indicates the group title.

Indicates the section title.

Indicates the group number.

Indicates the section number.

Indicates the page number.

6A1 ENGINE - Water Pump and Water Pipe

11A-7-1

7. WATER PUMP AND WATER PIPE REMOVAL AND INSTALLATION

Denotes tightening torque.

Nm Kgm ft.lbs.

Denotes non-reusable part.

This number corresponds to the number appearing in "Removal steps", "Disassembly steps", "Installation steps" or "Reassembly steps".

Operating procedures, cautions, etc. on removal, installation, disassembly and reassembly are described.

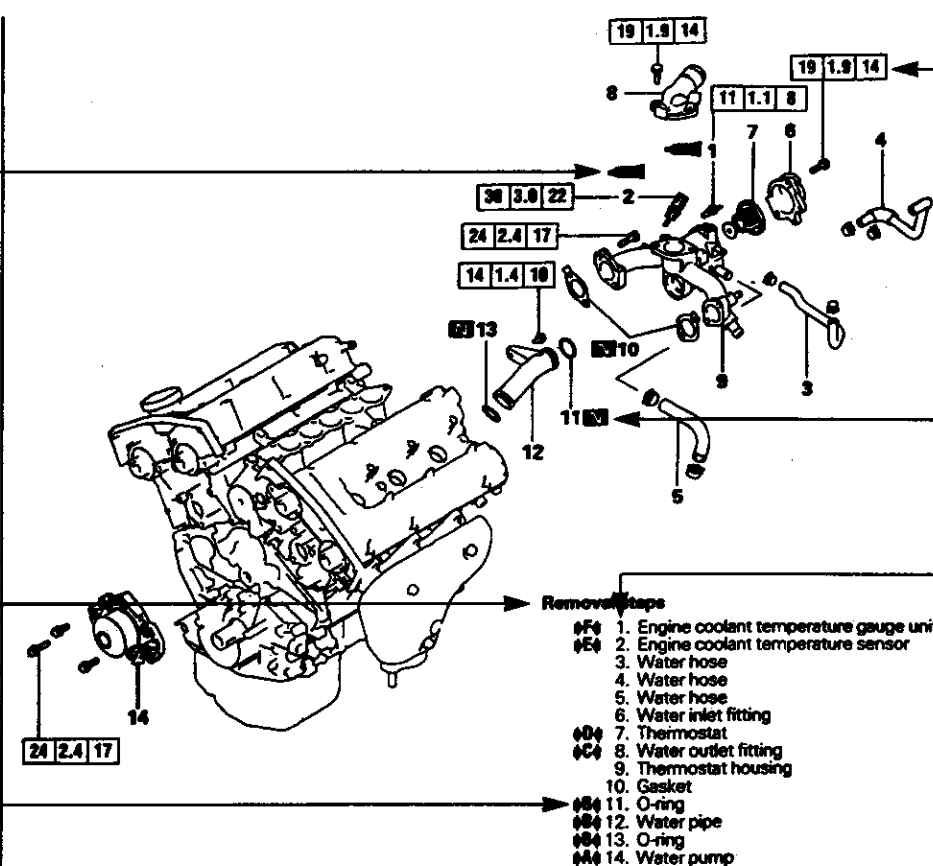

INSTALLATION SERVICE POINTS

Ⓐ SEALANT APPLICATION TO WATER PUMP

Specified sealant:
Mitsubishi Genuine Part No. MD970389 or equivalent

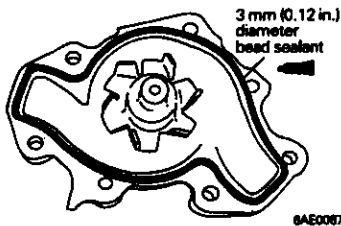

© Mitsubishi Motors Corporation Dec. 1992

PWEE2002

Issue date

Publication number-
Revision code

List of Effective Pages

Page	Revision code	Date	Remarks
11A-0-1	A	July 1992	
11A-0-3 to 11A-0-9		Aug. 1990	
11A-1-1 to 11A-1-14		Aug. 1990	
11A-2-1 to 11A-2-4		Aug. 1990	
11A-3-1 to 11A-3-9		Aug. 1990	
11A-4-1 to 11A-4-10		Aug. 1990	
11A-5-1 to 11A-5-4		Aug. 1990	
11A-6-1 to 11A-6-4		Aug. 1990	
11A-7-1 to 11A-7-4		Aug. 1990	
11A-8-1 to 11A-8-5		Aug. 1990	
11A-9-1 to 11A-9-3		Aug. 1990	
11A-10-1 to 11A-10-3		Aug. 1990	
11A-11-1 to 11A-11-6		Aug. 1990	
11A-12-1 to 11A-12-5		Aug. 1990	
11A-13-1 to 11A-13-11		Aug. 1990	
11A-14-1 to 11A-14-8		Aug. 1990	
11A-15-1 to 11A-15-5		Aug. 1990	
11A-16-1 to 11A-16-3		Aug. 1990	
11B-0-1	C	Sept. 1995	
11B-0-2	B	Aug. 1994	
11B-0-3 and 11B-0-4	A	July 1992	
11B-0-5	B	Aug. 1994	
11B-0-6	A	July 1992	
11B-0-6a and 11B-0-6b	B	Aug. 1994	
11B-0-7 to 11B-0-10	A	July 1992	
11B-1-1 and 11B-1-2	D	Aug. 1996	Revised
11B-1-3 and 11B-1-4	C	Sept. 1995	
11B-1-5 to 11B-1-10	D	Aug. 1996	Revised
11B-1-11	C	Sept. 1995	
11B-1-12 to 11B-1-15	D	Aug. 1996	Revised
11B-1-16	D	Aug. 1996	Added
11B-2-1 and 11B-2-2	A	July 1992	
11B-2-3	C	Sept. 1995	
11B-2-4 and 11B-2-5	B	Aug. 1994	
11B-3-1 to 11B-3-4	C	Sept. 1995	
11B-3-5 to 11B-3-7	B	Aug. 1994	
11B-4-1	D	Aug. 1996	Revised
11B-4-2	C	Sept. 1995	
11B-4-2a	D	Aug. 1996	Revised
11B-4-2b and 11B-4-3	C	Sept. 1995	
11B-4-4	A	July 1992	
11B-4-5	B	Aug. 1994	

Page	Revision code	Date	Remarks
11B-4-6	A	July 1992	
11B-4-7	C	Sept. 1995	
11B-4-8 and 11B-4-9	A	July 1992	
11B-4-10	B	Aug. 1994	
11B-4-11 and 11B-4-12	C	Sept. 1995	
11B-4-13 to 11B-4-17	A	July 1992	
11B-4-18 and 11B-4-19	C	Sept. 1995	
11B-5-1	B	Aug. 1994	
11B-5-1a	D	Aug. 1996	Revised
11B-5-1b	B	Aug. 1994	
11B-5-2 and 11B-5-3	D	Aug. 1996	Revised
11B-5-4 to 11B-5-6	B	Aug. 1994	
11B-5-6a	D	Aug. 1996	Revised
11B-5-6b	B	Aug. 1994	
11B-5-7	C	Sept. 1995	
11B-5-8	A	July 1992	
11B-6-1	A	July 1992	
11B-6-2	D	Aug. 1996	Revised
11B-6-3	B	Aug. 1994	
11B-6-3a and 11B-6-3b	D	Aug. 1996	Revised
11B-6-3c and 11B-6-3d	D	Aug. 1996	Added
11B-6-4 to 11B-6-6	C	Sept. 1995	
11B-6-7	D	Aug. 1996	Revised
11B-7-1	A	July 1992	
11B-7-2	B	Aug. 1994	
11B-7-2a	D	Aug. 1996	Revised
11B-7-2b and 11B-7-3	C	Sept. 1995	
11B-7-4	D	Aug. 1996	Revised
11B-8-1 and 11B-8-2	A	July 1992	
11B-8-3	D	Aug. 1996	Revised
11B-8-4	C	Sept. 1995	
11B-8-5 to 11B-8-7	D	Aug. 1996	Revised
11B-8-8 to 11B-8-10	A	July 1992	
11B-8-11	D	Aug. 1996	Revised
11B-8-12	C	Sept. 1995	
11B-9-1 and 11B-9-2	B	Aug. 1994	
11B-9-3	C	Sept. 1995	
11B-9-4 and 11B-9-5	A	July 1992	
11B-9-6 to 11B-9-12	C	Sept. 1995	
11B-10-1	D	Aug. 1996	Revised
11B-10-2 and 11B-10-3	B	Aug. 1994	
11B-10-4	A	July 1992	
11B-10-5	B	Aug. 1994	

Page	Revision code	Date	Remarks
11B-10-6 to 11B-10-8	A	July 1992	
11B-10-9	B	Aug. 1994	
11B-10-10	A	July 1992	
11B-11-1	C	Sept. 1995	
11B-11-2	A	July 1992	
11B-11-3 and 11B-11-4	C	Sept. 1995	
11B-11-5 and 11B-11-6	A	July 1992	
11B-11-7	C	Sept. 1995	

Page	Revision code	Date	Remarks
11B-11-8 and 11B-11-9	B	Aug. 1994	
11B-12-1	D	Aug. 1996	Revised
11B-12-2	A	July 1992	
11B-12-3 and 11B-12-4	C	Sept. 1995	
11B-12-5	D	Aug. 1996	Revised
11B-12-6	B	Aug. 1994	
11B-13-1	A	July 1992	

Missing sheets will be supplied upon request.

PWEE9037-D